

T CONNECTOR LEFT 1

3-CIRCUIT DALI TRACK SYSTEM



COLOURS



OPTIONS

Dimmable



Product code Black (RAL 9011)
EAN Code Black

PRO-D636L1-B
8719747931660

Product code White (RAL 9010)
EAN code White

PRO-D636L1-W
8719747931646

Product code Grey (RAL7040)
EAN code Grey

PRO-D636L1-S
8719747931653

Main materials

PC UL94V0 + Copper + Steel

Net weight per piece

192 grams

Inner box / outer box

9 / 54 pcs

Rated voltage per circuit

230V / 16A

DIMENSIONS

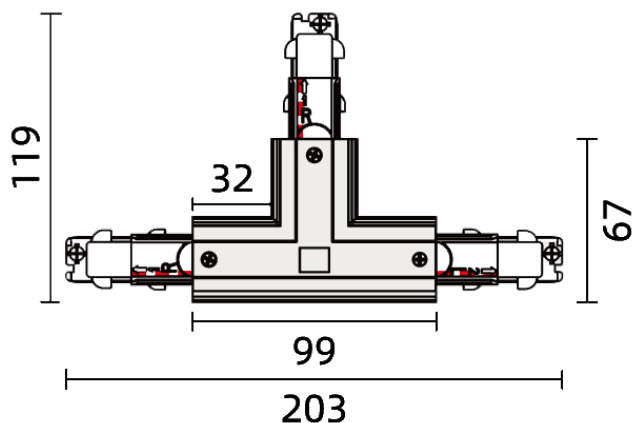

RED LINE INDICATES POLARITY RIDGE



RoHS

